

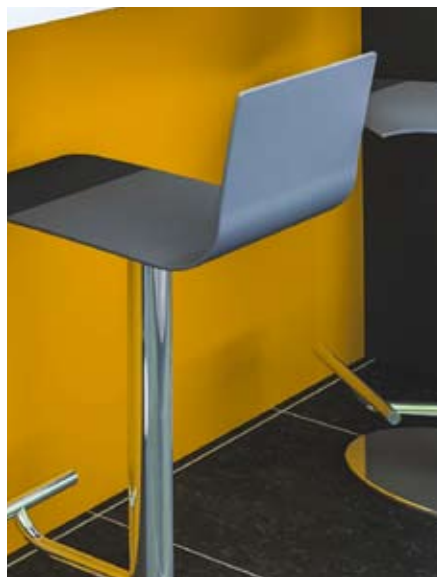

# Principal.

## KITCHEN RANGE CATALOGUE



# It's your decision

The very best kitchen solutions from around the world have been brought together to create a stunning range of modular kitchens, all available to order today.

Durability is key across the entire Principal range with doors and drawer fronts in quality laminate, UV, acrylic and 2 pack painted finishes, cabinets built in Australia, German soft close drawers, Italian soft close hinges. The care and attention to detail we put into every kitchen makes a world of difference.

## The Principal quality

Every detail of the kitchen you're about to discover has been designed around the very best in contemporary living. With clever storage solutions, the latest finishes and special touches to make your kitchen distinctly your own, Principal helps set a new standard in kitchen design trends. Discover durable and stylish benchtops and finish your room with sinks and tapware. From traditional looks to ultra cool and contemporary, there really is something to inspire everyone in a Principal kitchen.

Installing your Principal kitchen couldn't be easier with all assembly hardware included in our cabinet packs such as hinges, runners, screws and cabinet feet. No separate purchases of this hardware or fasteners are required.

## Finest quality finishes

Our kitchens are finished with the finest quality doors and drawer fronts in laminate, UV, acrylic and 2 pack painted finishes, Italian soft close hinges, and drawer runners and hardware from Häfele and Kessebohmer. For the ultimate peace of mind, all of these components come with a 10 year guarantee.

## Premium 18mm doors

Quality and durability is key. Substantial 18mm doors on all our kitchens provide that premium feel and reduce the risk of bowing.

## With you all the way

Our in store designers are on hand to help you select the right kitchen for your home and your lifestyle. And they know every detail of the kitchens inside and out, to give you the right advice first time, every time.

## Available to order and ready when you are

Subject to availability, your kitchen will usually be ready to deliver in as little as 14 days.

## Our warranty - built for life

Your kitchen is the heart to the home. So it's great to know your Principal kitchen is backed by a 10 year guarantee. All cabinetry features solid backs, high moisture resistant E1 Australian particle board, quality PVC edging on all exposed edges of the cabinetry and multiple support rails to take substantial weight. Which means you can be sure your kitchen will withstand the realities of modern life.

## The Environment

Principal kitchens are committed to the environment and reducing the impact we're all having on the world's natural resources. With that in mind, we created a very high set of environmental standards for our kitchens.

- > All cabinetry and doors are made using board supplied from controlled sources.
- > We use E1 (low formaldehyde emitting) rated timber board and panels in the manufacturing of all cabinets, doors and laminate benchtops.

# Contents

<b>04</b>   PLANNING	<b>36</b>   SHOWCASE DOORS	<b>62</b>   BASE STORAGE
PRINCIPAL DOORS   <b>06</b>	LAUNDRY   <b>38</b>	CORNER SOLUTIONS   <b>63</b>
<b>08</b>   METRO	<b>40</b>   DESIRE PAINTED DOOR	<b>64</b>   OVERHEAD STORAGE
ALFRESCO   <b>10</b>	OUTDOOR KITCHEN   <b>42</b>	DRAW ORGANISATION   <b>65</b>
<b>12</b>   BRIGHTON	<b>44</b>   CABINETS	<b>66</b>   WASTE & LAUNDRY MANAGEMENT
MISSION BEACH   <b>14</b>	LAMINATE BENCHTOP   <b>46</b>	ACCESSORIES   <b>68</b>
<b>16</b>   FUJI WHITE	<b>48</b>   STONE BENCHTOPS	<b>69</b>   LIGHTING
JAPANESE PEAR   <b>18</b>	GLASS SPLASHBACK   <b>50</b>	PLANNING TIPS   <b>70</b>
<b>20</b>   PURITY	<b>51</b>   POLYMER SPLASHBACK	<b>71</b>   END PANELS & CAVITIES
SHAKER   <b>22</b>	STANDARD HANDLES   <b>52</b>	MEASURING TIPS   <b>72</b>
<b>24</b>   HAMPTON	<b>53</b>   PREMIUM HANDLES	<b>73</b>   DESIGN SPACE
NEWPORT   <b>26</b>	APPLIANCES   <b>54</b>	DELIVERY & INSTALL   <b>74</b>
<b>28</b>   SORRENTO	<b>56</b>   SINKS	<b>75</b>   ESSENTIALS CHECKLIST
BEAUMARIS   <b>30</b>	TAPWARE   <b>58</b>	6 CABINET DESIGN   <b>76</b>
<b>32</b>   KIRRA	<b>59</b>   FILTRATION	<b>77</b>   ZIP MONEY
ALLURE DOORS   <b>34</b>	PANTRY SOLUTIONS   <b>60</b>	WARRANTY INFORMATION   <b>78</b>



# Planning

## Are you ready to plan your new kitchen?

Visit [principal.2020.net](http://principal.2020.net) today to start designing. Measure your space and plan your new kitchen using our online kitchen designer. Create your room, choose kitchen style, drop and drag kitchen elements - once its complete, you can share your design with friends or print it out as a shopping list to take into your local store to order.

A new kitchen doesn't have to be hard work, this helpful planning guide is full of tips and advice to help you create your dream kitchen. First up, you need to think about the basics. What do you need from your kitchen?

This is probably the most important question, because apart from looking great it really needs to function well.

## Think about these things and make a list:

- > How will your family use it?
- > Do you need more storage than you have now?
- > Do you need more drawers or places to store pots and pans?
- > Will you need space for a dishwasher?
- > Is a pantry an option?



## The working triangle:

Consider the natural flow between work zones in the kitchen. This work path is often referred to as the 'working triangle'. The working triangle illustrates the path between the most frequently used work areas, such as the fridge, sink and cooking appliances. Reducing the size of the working triangle will save you time and effort in your new kitchen. Using these four common kitchen layouts (Straight line, L-shape, U-shape and Galley), and referring to the working triangle, select the design most suited to your new kitchen.

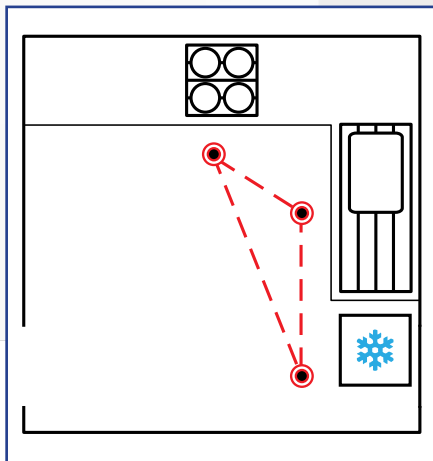

## L-SHAPED KITCHEN

One of the most common layouts is the L-shaped kitchen, ideal for homes incorporating a small table for dining in the kitchen space.



 = Fridge  = Cooktop  = Sink



# Principal.

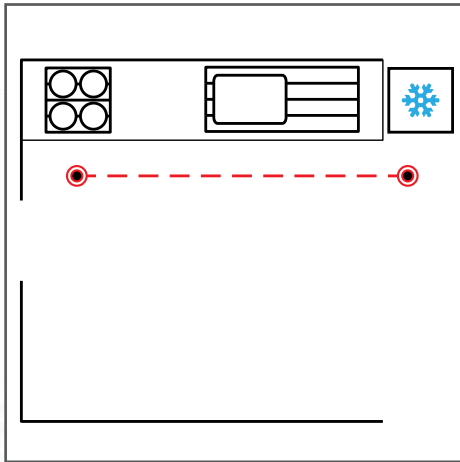

## STRAIGHT LINE KITCHEN

This layout is best when the space available for your new kitchen is limited. There is no working triangle shown because the workflow is based on a straight line.

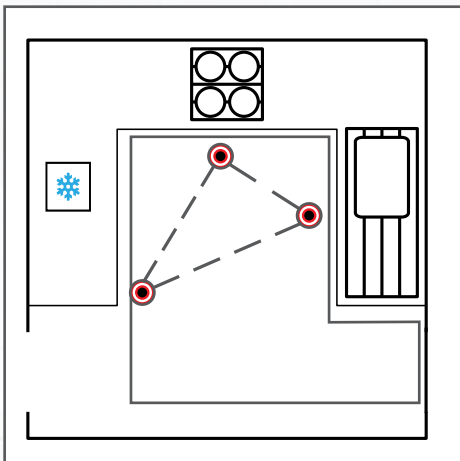

## U-SHAPED KITCHEN

If you have a large room, and want the most efficient working triangle, then the U-shaped kitchen is ideal. It is also perfect for the demands of a family, offering maximum storage space with many wall cabinet options.

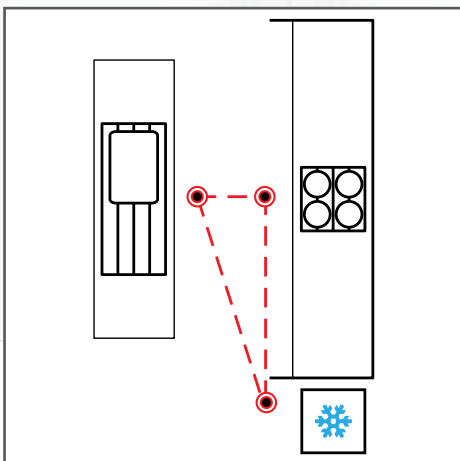

## GALLEY KITCHEN

This layout is featured in many homes, as it provides two opposing working and storage areas. Add a couple of bar stools to the island unit and this becomes a great kitchen for entertaining. Ideal for open plan living.



# Principal.

## PRINCIPAL DOORS

The Principal range features 18mm doors as standard and is manufactured using only sustainable timber sources.

Quality and durability is key across the entire Principal range. Offering doors and drawer fronts in laminate, UV, acrylic and 2 pack painted finishes, the substantial 18mm doors provide that premium feel and reduce the risk of bowing



# Principal.

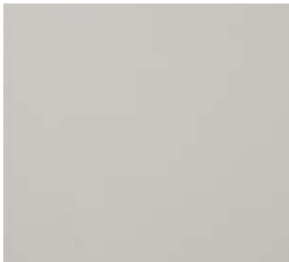

**METRO** PAGE 8  
White Matt  
Premium Melamine



**ALFRESCO** PAGE 10  
Woodgrain Matt  
Premium Melamine



**BRIGHTON** PAGE 12  
Light Grey Gloss  
UV Lacquer

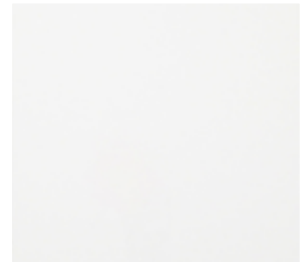

**MISSION BEACH** PAGE 14  
White Gloss  
UV Lacquer



**FUJI WHITE** PAGE 16  
White Gloss  
Acrylic



**JAPANESE PEAR** PAGE 18  
Woodgrain Gloss  
UV Lacquer



**PURITY** PAGE 20  
White Gloss  
2 pack paint



**SHAKER** PAGE 22  
White Satin  
2 pack paint



**HAMPTON** PAGE 24  
White Gloss  
2 pack paint

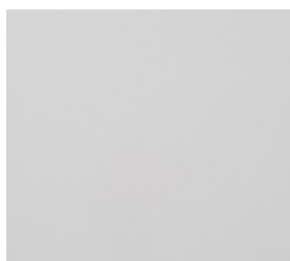

**NEWPORT** PAGE 26  
White Gloss  
2 pack paint



**SORRENTO** PAGE 28  
Dark Grey Gloss  
UV Lacquer



**BEAUMARIS** PAGE 30  
Grey Metallic Gloss  
Acrylic



**KIRRA** PAGE 32  
White satin  
2 pack paint



**ALLURE** PAGE 34  
Frosted Glass  
Aluminium Frame



**SHOWCASE** PAGE 36  
White Gloss, Clear Glass  
2 pack paint



**VISTA**  
White Satin, Clear Glass  
2 pack paint



# Principal.

## METRO

Classic, timeless and clean lines. Metro white doors work perfectly in any kitchen. This sleek, straight line design is perfect for a studio space. The clean, simple lines hide a myriad of features like plate drawers with a smooth soft close motion. All at a price that will amaze you.



**METRO**  
White Matt  
Premium Melamine



# Principal.



Benchtops, splashback, handles, sinks, taps, appliances and accessories are available as optional extras

# Principal.



Benchtops, splashback, handles, sinks, taps, appliances and accessories are available as optional extras



# Principal.

## ALFRESCO

Alfresco provides a modern fine grain timber look. This impressive galley style design with a contemporary colour scheme and bold accents is a classic example of a kitchen you would normally find in a designer apartment or home all with a smooth soft close action.



# Principal.

## BRIGHTON

Featuring UV lacquer with an ultra high gloss finish for high impact. Brighton is eye catching and stylish in neutral grey and has a matching colour polymer edge on the doors and drawer fronts.



**BRIGHTON**  
Light Grey Gloss  
UV Lacquer



# Principal.



Benchtops, splashback, handles, sinks, taps, appliances and accessories are available as optional extras



# Principal.



Benchtops, splashback, handles, sinks, taps, appliances and accessories are available as optional extras

# Principal.

## MISSION BEACH

Brighten up your kitchen with Mission Beach white gloss doors and drawers. Great for rooms needing protection against light due to the UV lacquer finish.

**MISSION BEACH**  
White Gloss  
UV Lacquer

# Principal.

## FUJI WHITE

A stunning collection of ultra modern doors with a high gloss acrylic white finish and a stunning 3D glass effect edge - producing deceptively real glazed appearance. Pictured here in a galley design, the practical layout makes modern living easy and elegant.



**FUJI WHITE**  
White Gloss  
Acrylic





# Principal.



Benchtops, splashback, handles, sinks, taps, appliances and accessories are available as optional extras

# Principal.



Benchtops, splashback, handles, sinks, taps, appliances and accessories are available as optional extras

# Principal.

## JAPANESE PEAR

Featuring a luxurious 3D edge, the high gloss UV lacquer doors offer an exceptionally modern glass effect and deceptively real glazed appearance. The galley styled L-shaped layout, pictured here, maximises the available wall space whilst allowing plenty of room for entertaining friends and family.



**JAPANESE PEAR**  
Woodgrain Gloss  
UV Lacquer





# Principal.

## PURITY

A simple, yet sleek and modern high gloss white kitchen. The integrated J-pull handle routed into the door creates a sophisticated designer look and avoids the need for handles.



**PURITY**  
White Gloss  
2 pack paint



# Principal.



Benchtops, splashback, handles, sinks, taps, appliances and accessories are available as optional extras

# Principal.



Benchtops, splashback, handles, sinks, taps, appliances and accessories are available as optional extras



# Principal.

## SHAKER

Shaker's crisp white colour and satin texture combination creates a simple kitchen of striking contrasts.

Drawing its inspiration from the classic European Shaker door, is instantly appealing and works equally well in a small space as it does in a larger one.



# Principal.

## HAMPTON

Hampton is a timeless kitchen style and is immediately obvious why its appeal never diminishes. A classically styled white gloss finish with french cut detail and raised centre panel commands attention, whilst providing warmth and versatility to combine with a multitude of benchtop and splashback decors. Featured here is the Showcase glass door, a perfect match to the Hampton finish.



**HAMPTON**  
White Gloss  
2 pack paint



# Principal.



Benchtops, splashback, handles, sinks, taps, appliances and accessories are available as optional extras



# Principal.

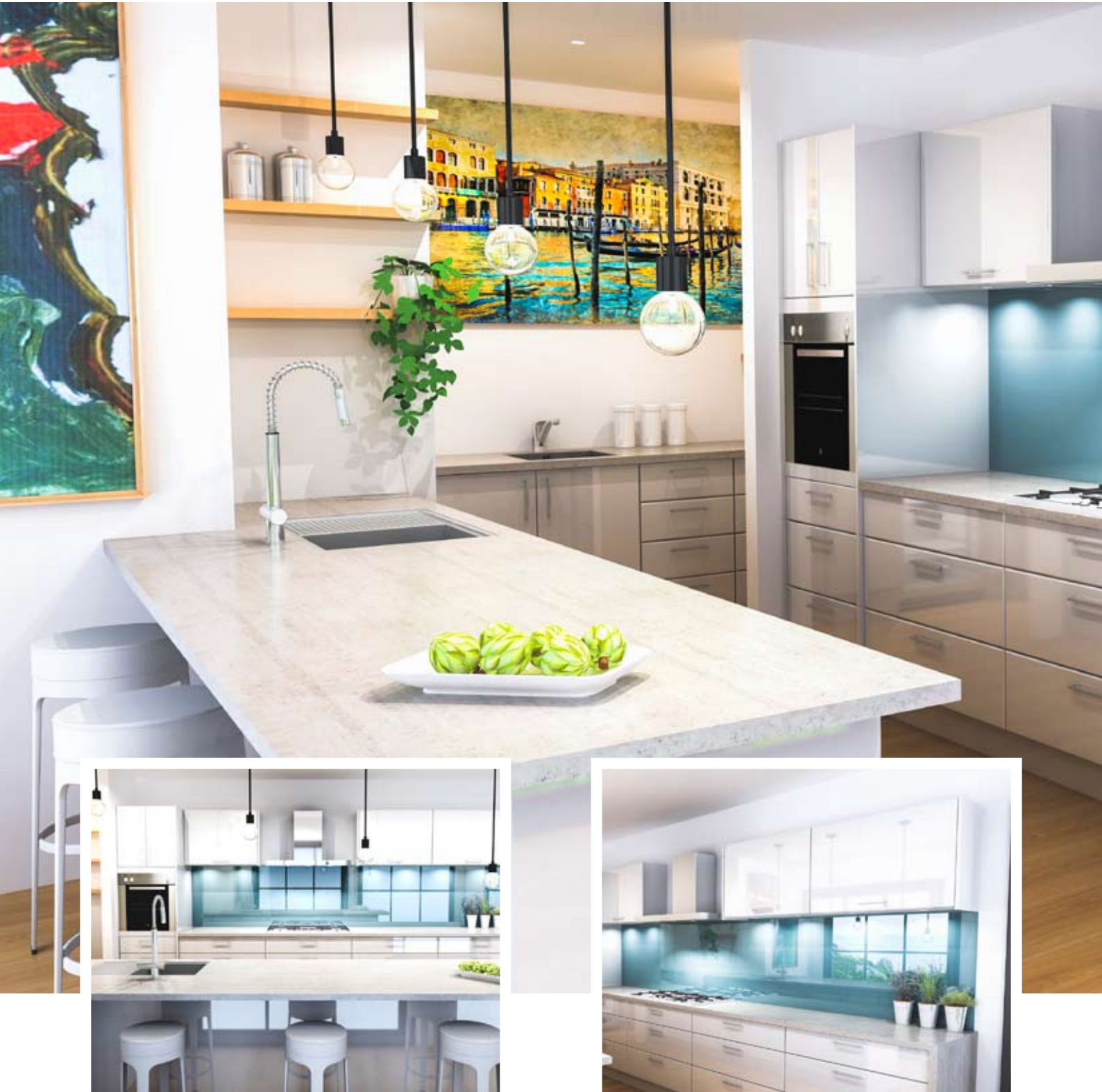

Benchtops, splashback, handles, sinks, taps, appliances and accessories are available as optional extras

# Principal.

## NEWPORT

Create the ultimate in crisp, sleek minimalist design with timeless gloss white Newport.

The cool gloss finish of this sleek, modern kitchen creates immediate impact in your home.

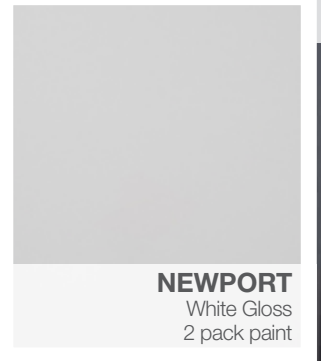

**NEWPORT**  
White Gloss  
2 pack paint



# Principal.

## SORRENTO

Effortlessly eye catching, the high gloss finish of this sleek, modern kitchen creates immediate impact in your home.

Features UV lacquered door with colour matched edging.



**SORRENTO**  
Dark grey Gloss  
UV Lacquer





# Principal.



Benchtops, splashback, handles, sinks, taps, appliances and accessories are available as optional extras

# Principal.



Benchtops, splashback, handles, sinks, taps, appliances and accessories are available as optional extras

# Principal.

## BEAUMARIS

Chic in metallic grey, this kitchen has an ultra high gloss finish with an illuminating glass effect.





# Principal.

## KIRRA

Made and crafted in Italy, the Kirra style provides a modern matt white textured finish and seamless 2 pack painted door.



**KIRRA**  
White satin  
2 pack paint



# Principal.



Benchtops, splashback, handles, sinks, taps, appliances and accessories are available as optional extras

# Principal.



Benchtops, splashback, handles, sinks, taps, appliances and accessories are available as optional extras



# Principal.

## ALLURE

This modern design features frosted toughened glass and aluminium frame shown here with mission beach doors and drawers. Add in cabinetry lighting to complete the look.



**ALLURE**  
Frosted Glass  
Aluminium Frame



# Principal.

## SHOWCASE

The showcase overhead doors feature 4mm toughened glass, a gloss white finish frame and is crafted in Italy.

Paired here with the Principal Hampton doors, this style will give your kitchen an elegant and unique look.



### SHOWCASE

White Gloss, Clear Glass  
2 pack paint



# Principal.



Benchtops, splashback, handles, sinks, taps, appliances and accessories are available as optional extras



# Principal.



Benchtops, splashback, handles, sinks, taps, appliances and accessories are available as optional extras

# Principal.

## LAUNDRY

Shown here in the Mission Beach option, match your laundry with your kitchen using all Principal doors and cabinetry to complete your style.

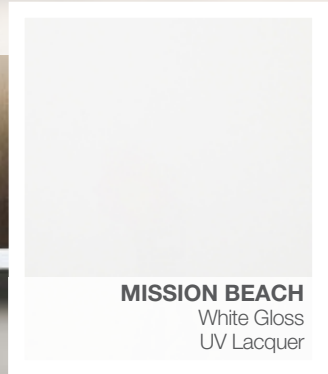

**MISSION BEACH**  
White Gloss  
UV Lacquer

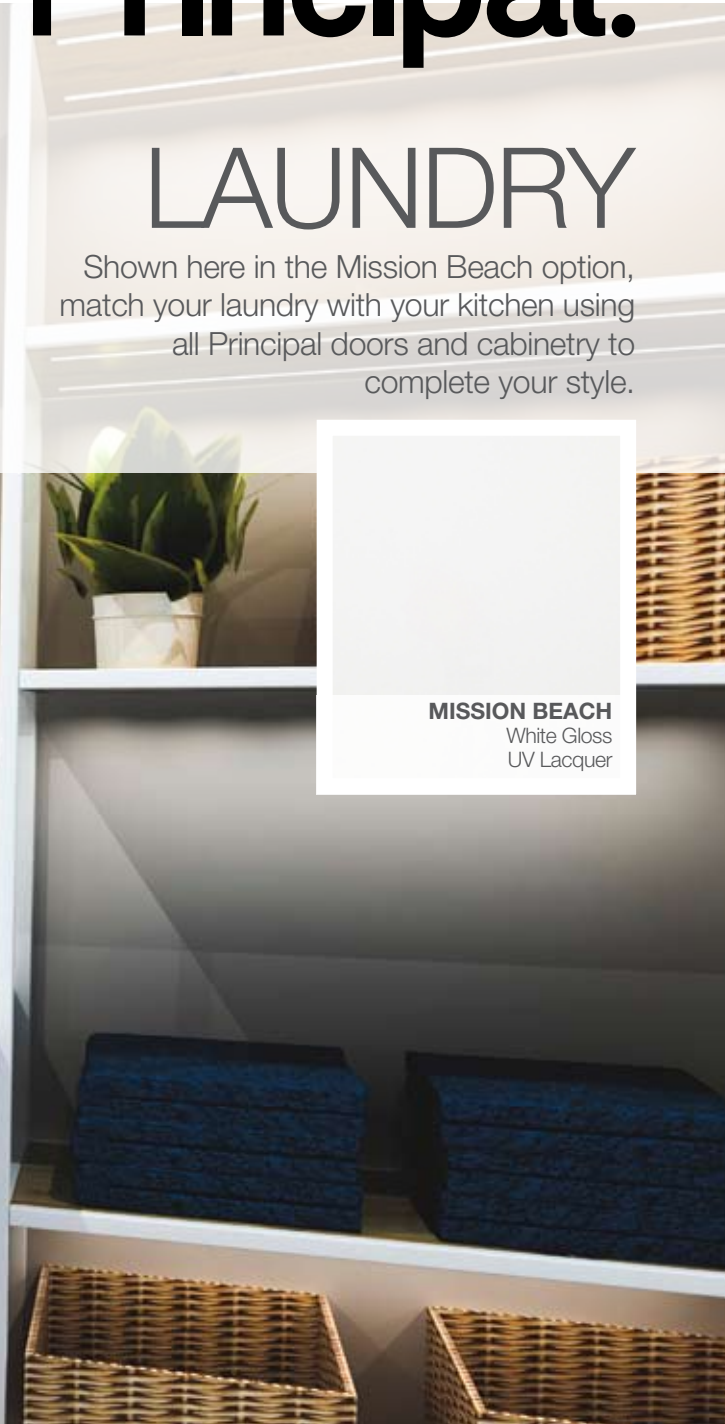

# Principal.

## DESIRE PAINTED DOORS

The Desire painted door range has been developed to bring you unlimited options when designing your kitchen. You can choose from 4 unique door designs, unlimited colour options from the Dulux colour palette and two finishes.





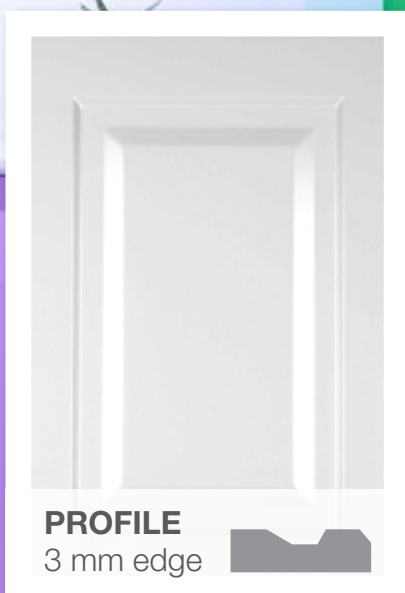
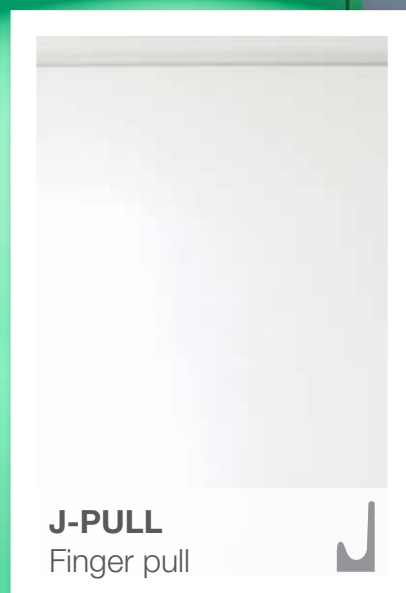
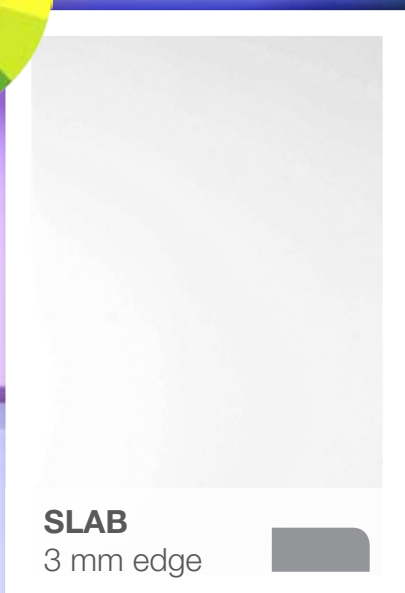

# Principal.

## ALFRESCO OUTDOOR KITCHEN

Available in 4 configurations with 6 compact laminate door front options. Designed with treated foam fill cabinetry for outdoor use, complete with granite benchtops to help create your ultimate outdoor dining experience.

### Available in 6 door colours

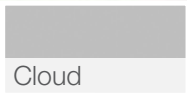

Cloud

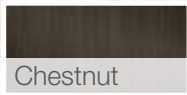

Chestnut

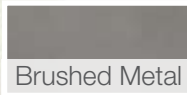

Brushed Metal

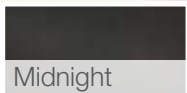

Midnight

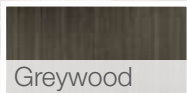

Greywood



Vintage White

### Available in 3 benchtop colours

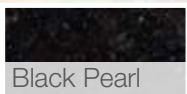

Black Pearl



Steel Grey

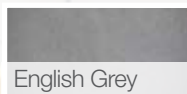

English Grey



CA 3  
Cloud

# Principal.





# Principal.

## CABINETS

Our Principal cabinetry range has a huge number of options from base, tall wall, short wall, oven, microwave, pantry, drawer as well as corner options.

All our cabinets are made in Australia from E1 highly moisture resistant board.

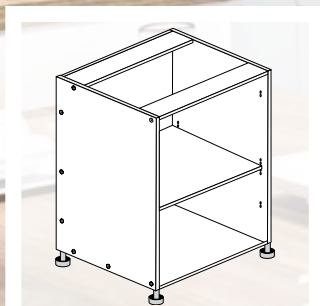

**BASE CABINET**

150, 200, 300, 350, 400, 450, 500, 600, 700, 800, 900, 1000 mm

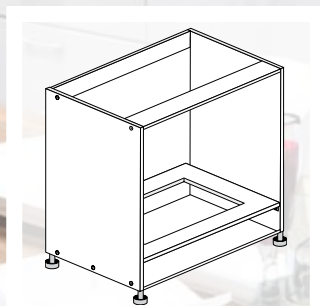

**OVEN CABINET**

600 & 900 mm

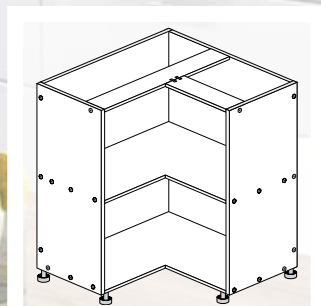

**CORNER CABINET**

900 x 900mm

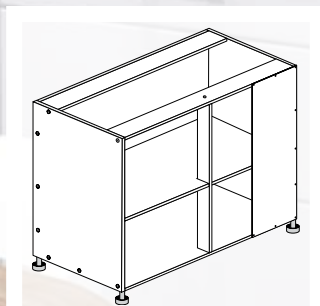

**BLIND CNR CABINET**

1100mm

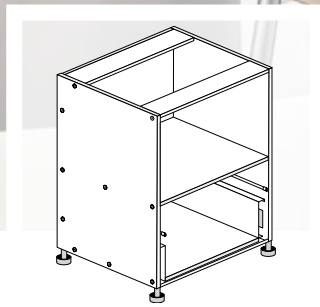

**CABINET WITH 1 DRAWER**

600mm

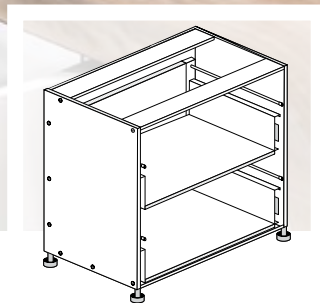

**CABINET WITH 2 DRAWER**

900mm

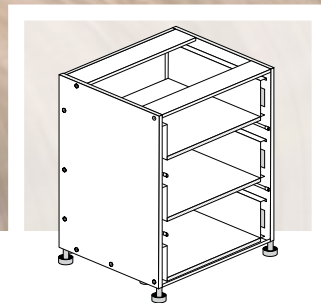

**CABINET WITH 3 DRAWER**

600, 800 & 900mm

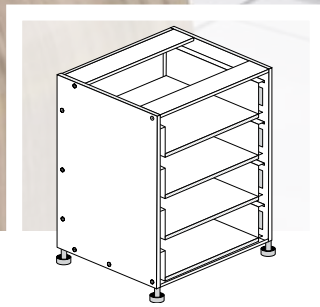

**CABINET WITH 4 DRAWER**

450mm

\*All drawers are soft close as standard\*



# Principal.

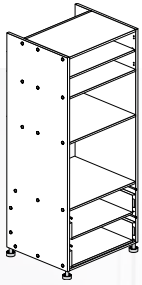

**2 DRAWER OVEN TOWER**  
600mm, with microwave opening

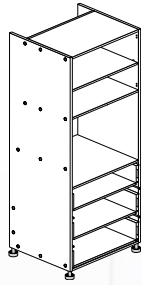

**3 DRAWER OVEN TOWER**  
600mm

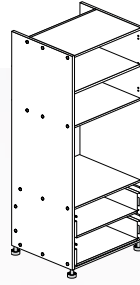

**DOUBLE OVEN TOWER**  
600mm, with 2 drawers

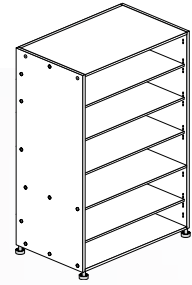

**PANTRY CABINET**  
300, 400, 450, 600, 800 & 900mm

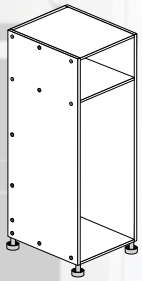

**PULL OUT PANTRY**  
300mm  
Mechanism sold separately

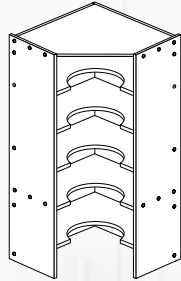

**CORNER PANTRY**  
1010mm, 2204mm high

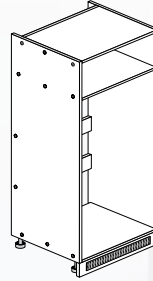

**INTEGRATED FRIDGE CAB**  
600mm

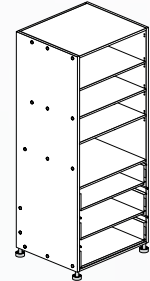

**3 DRAWER PANTRY CABINET**  
600mm, internal drawers

Height 592mm

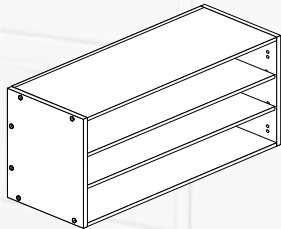

**SHORT WALL CABINET**  
150, 200, 300, 350, 400, 450,  
500, 600, 700, 800 & 900mm

Height 720mm

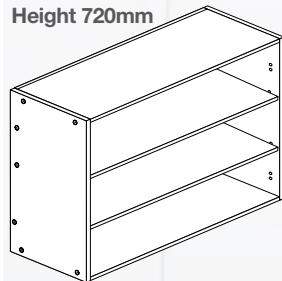

**TALL WALL CABINET**  
150, 200, 300, 350, 400, 450,  
500, 600, 700, 800 & 900mm

Height 592mm

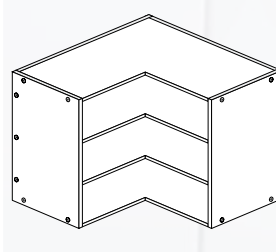

**SHORT CORNER WALL CABINET**  
600 x 600mm

Height 720mm

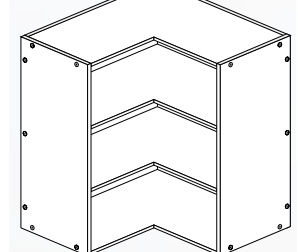

**TALL CORNER WALL CABINET**  
600 x 600mm

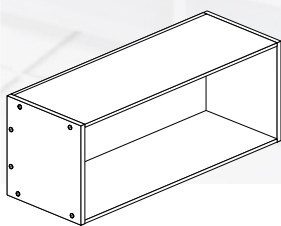

**OVER FRIDGE CABINET**  
800, 900 & 1000mm

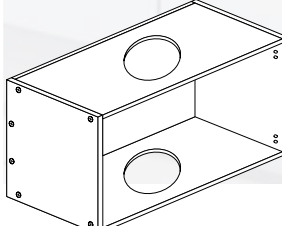

**RANGEHOOD CABINET**  
600 & 900mm

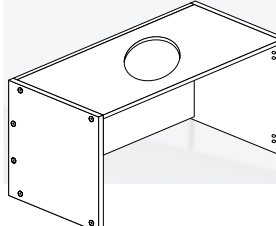

**INTEGRATED RANGEHOOD**  
600 & 900mm

592mm High

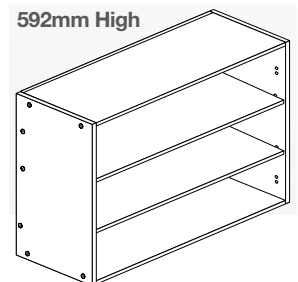

**SHORT FREE FLAP CABINET**  
800 & 900mm

\*All drawers are soft close as standard\*

# Laminate Benchtops

## HÄFELE

Laminate benchtops are designed for applications such as kitchen benchtops, counter tops, bathroom vanities and laundry benchtops where a durable decorative surface is required.

Our laminate benchtop range is:

- Tough and durable
- Resistant to cracking and chipping
- Moisture resistant E0 (lightweight) LDF substrate
- Available in 33mm and 40mm
- Available in gloss, matt and textured finishes (Matera only)
- Made in Australia

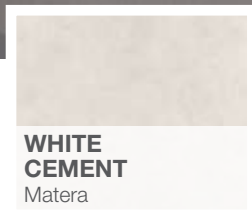
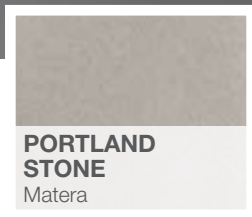
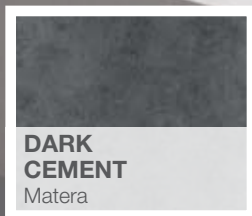
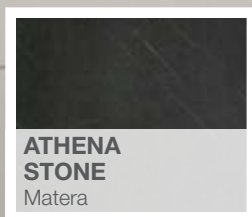

# Principal.

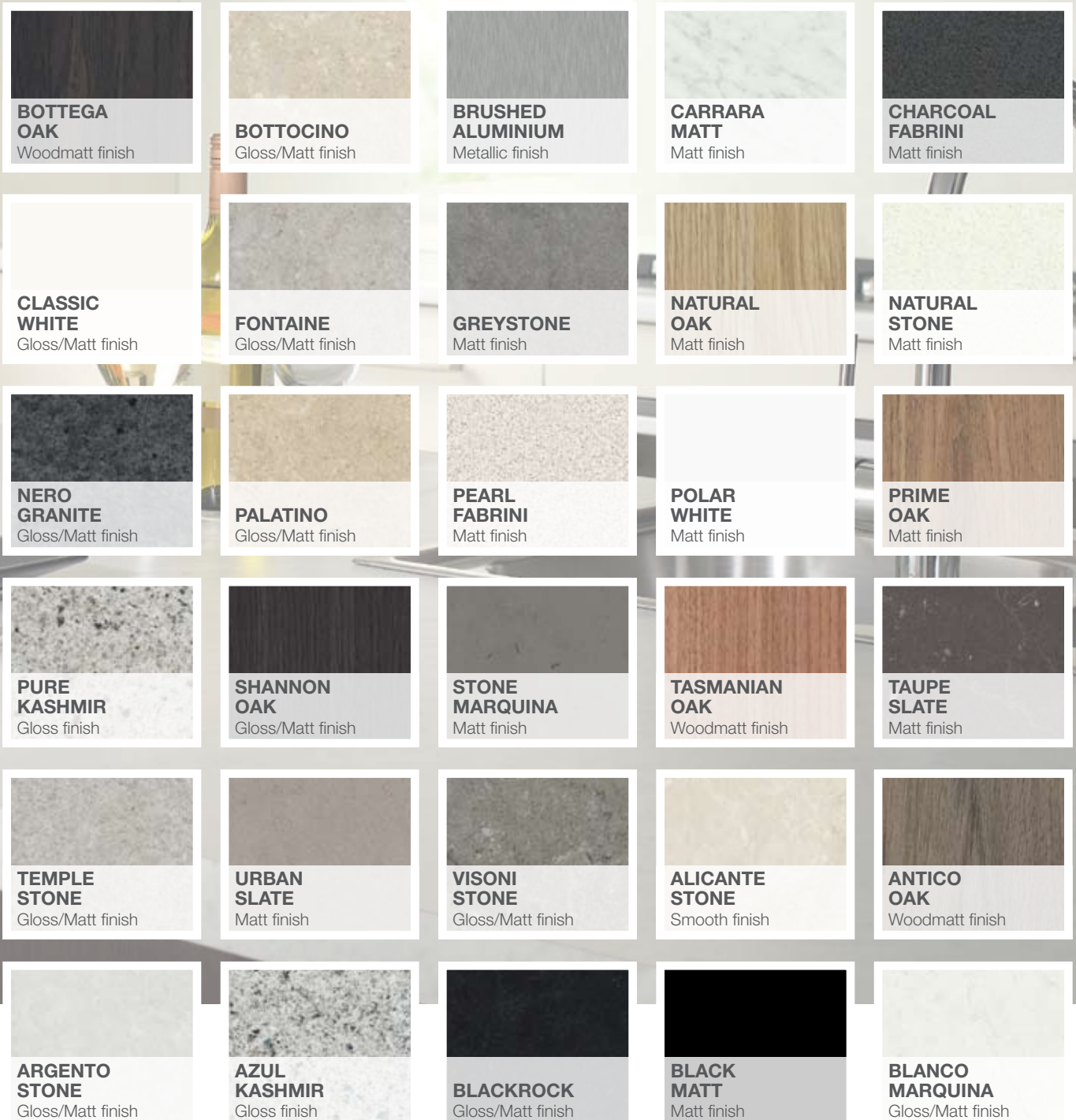

# Stone Benchtops

**Design freedom. Endless possibilities.**

Combining the beauty and strength of quartz – one of nature’s strongest minerals, Caesarstone® quartz surfaces retain the cool, tactile qualities of natural stone yet are resistant to stains, scratches, heat, mould and are easy to clean, making them excellent surfaces for kitchens, bathrooms & more.

 **caesarstone®**

**VoglioStone**

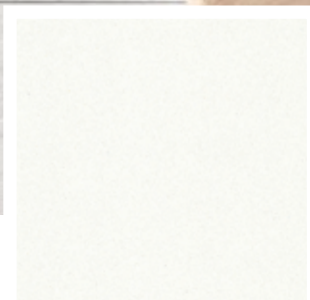

**SNOW**

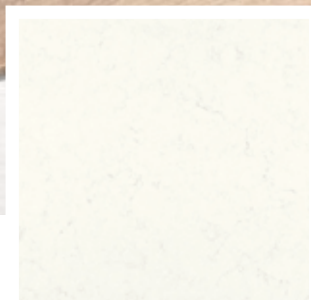

**FROSTY  
CARRINA**

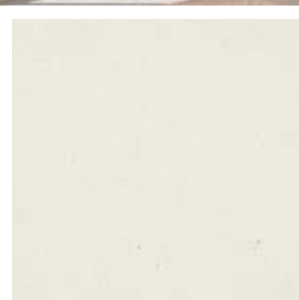

**FRESH  
CONCRETE**

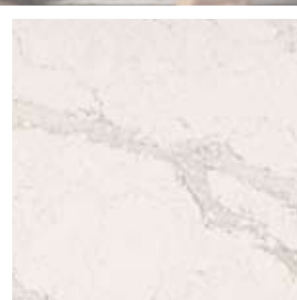

**CALACATTA  
NUVO**



# Principal.

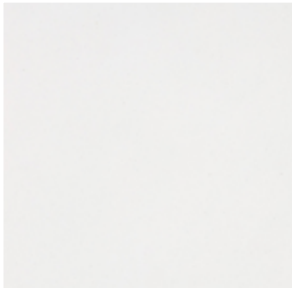

**PURE  
WHITE**

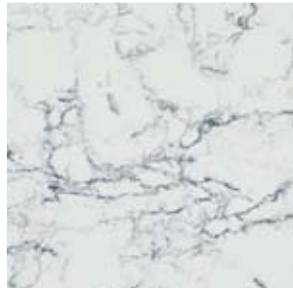

**WHITE  
ATTICA**

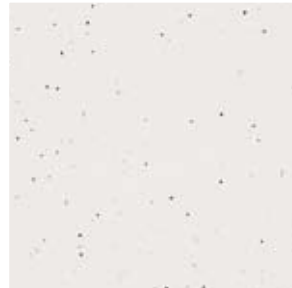

**FROZEN  
TERRA**



**WHITE  
SHIMMER**



**OSPREY**

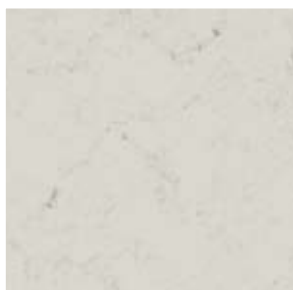

**LONDON  
GREY**



**LINEN**



**CLAMSHELL**



**GEORGIAN  
BLUFFS**



**ALPINE  
MIST**



**RAW  
CONCRETE**



**OYSTER**



**SHITAKE**



**WILD  
RICE**



**VANILLA  
NOIR**



**JET  
BLACK**

# Glass Splashback

VoglioGlass



**BRONZE**  
Mirror



**CLEAR**  
Mirror



**GREY**  
Mirror

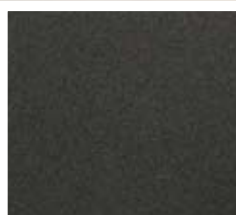

**TITANIC**  
Metallic

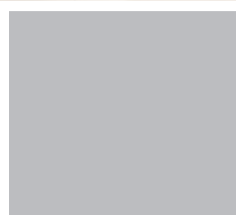

**ULTRA COURSE  
SILVER**  
Metallic



**DEEP  
SPACE**  
Metallic

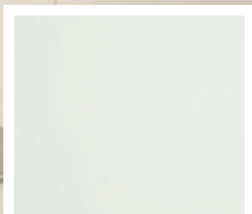

**ANTIQUE  
WHITE**  
Low Iron Solid

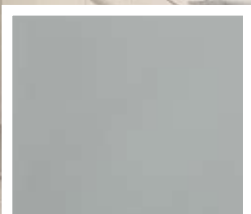

**FLOODED  
GUM**  
Low Iron Solid

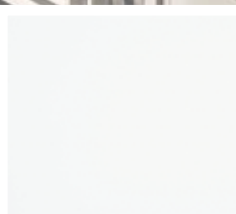

**WHITE**  
Low Iron Solid

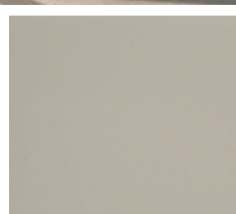

**MUDPACK**  
Low Iron Solid



**DRIVE  
TIME**  
Low Iron Solid

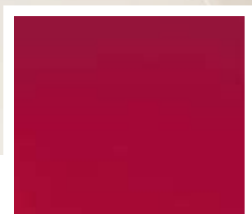

**RED  
BOX**  
Low Iron Solid

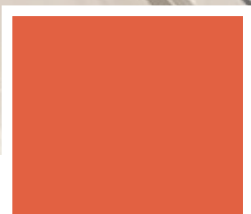

**FLAME**  
Low Iron Solid

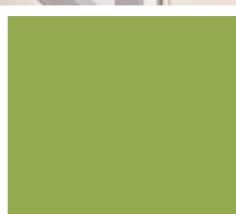

**GREENERY**  
Low Iron Solid

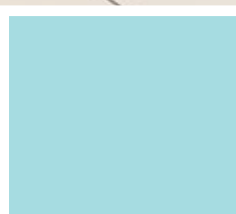

**ISLAND  
PARADISE**  
Low Iron Solid

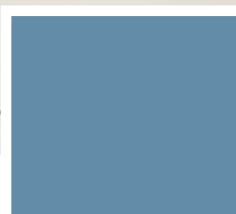

**NIAGARA**  
Low Iron Solid

# Polymer Splashback

Akril is a highly engineered polymer, enhanced with colour, that offers a new source of design inspiration.

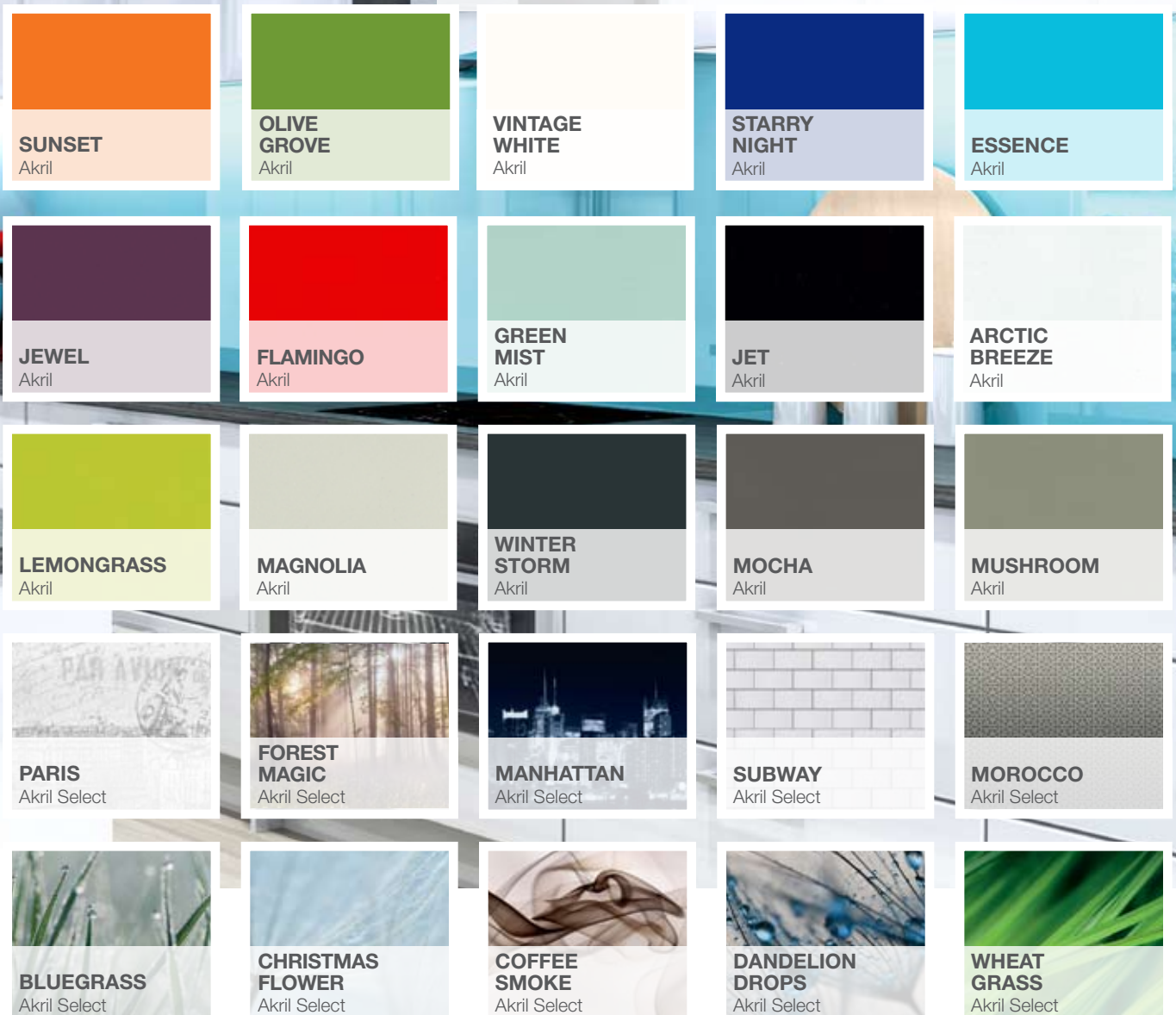

# Standard Handles

HÄFELE



**MATT CHROME PLATED  
T-BAR HANDLE**  
135 x 35mm 491.41.906

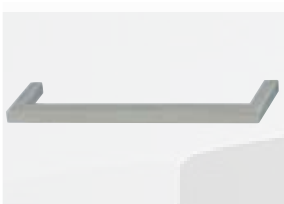

**MATT STAINLESS STEEL  
D HANDLE**  
170 x 35mm 491.41.056



**STAINLESS STEEL  
D HANDLE**  
136 x 27 mm 491.41.757

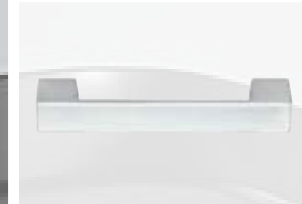

**MATT PLATED CHROME  
D HANDLE**  
128 x 25mm 491.42.054



**MATT PLATED CHROME  
D HANDLE**  
138 x 28mm 491.42.004

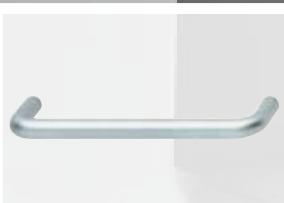

**MATT CHROME  
D HANDLE**  
106 X 35mm 491.06.215



**STAINLESS STEEL  
D HANDLE**  
172 x 25mm 491.42.207



**NICKEL MATT  
BOW HANDLE**  
148 x 30mm 491.42.359



**MATT PLATED CHROME  
BOW HANDLE**  
112 X 24mm 491.41.954



**MATT PLATED CHROME  
PULL HANDLE**  
172 x 24mm 491.61.026



**ANTIQUE IRON  
D HANDLE**  
136 x 33mm 491.41.504



**NICKEL-PLATED,  
BRUSHED KNOB**  
35 x 20mm 491.51.362



**ANTIQUE IRON  
KNOB**  
34 x 25mm 491.51.260



**ANTIQUE IRON  
KNOB**  
70 x 37mm 491.51.320



**POLISHED CHROME  
KNOB**  
20 x 25mm 491.51.380

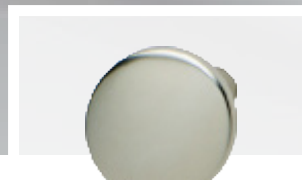

**NICKEL MATT  
KNOB**  
30 X 23mm 491.01.210



# Premium Handles

HÄFELE

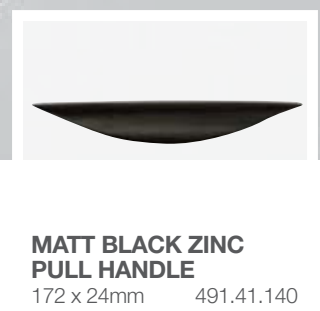
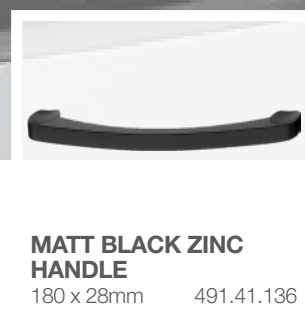
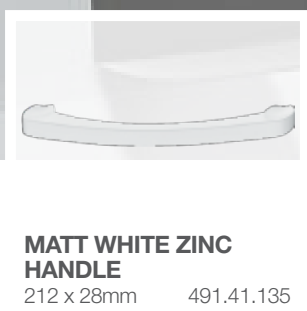
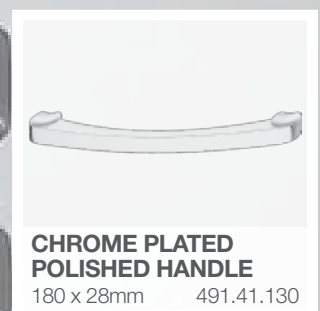
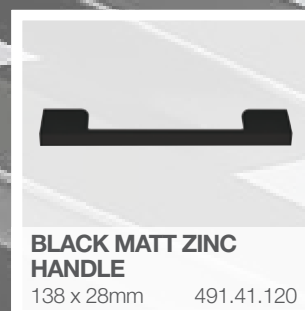
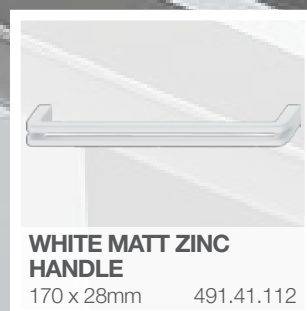
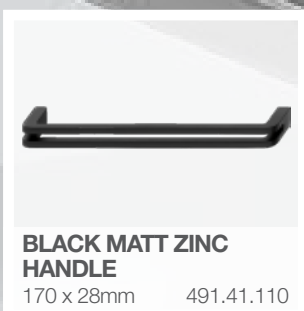
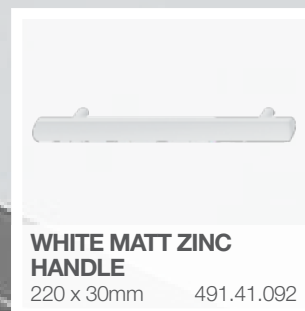
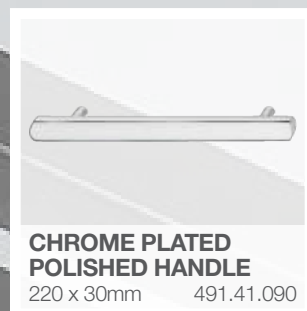
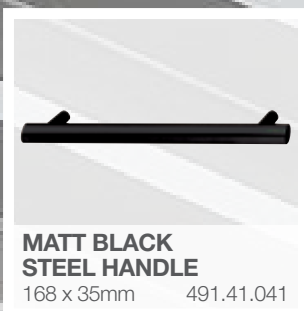
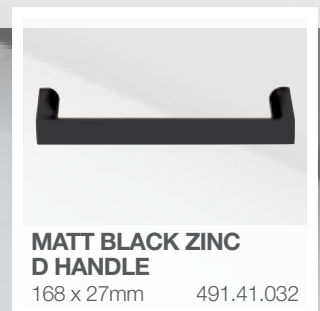
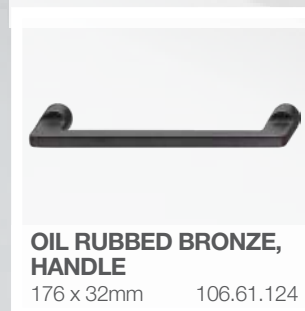

# Appliances



**60CM 4 BURNER  
GAS COOKTOP**

EV4BGSX



**60CM FAN FORCED  
5 FUNCTION OVEN**

EV600BSS2



**60CM SLIDE OUT  
RANGEHOOD**

ES602SS



**90CM 5 BURNER GAS  
COOKTOP & WOK  
BURNER**

EV90BGCSX



**90CM FAN FORCED  
7 FUNCTION OVEN**

EV900MSX



**90CM CANOPY  
RANGEHOOD**

EA90SX



**60CM ELECTRONIC  
CONTROL CERAN  
GLASS 4 ZONE  
COOKTOP**

ECT600C4



**90CM FREESTANDING  
ELECTRIC OVEN WITH  
GAS HOB & CAST IRON  
TRIVETS**

EV900DPSX



**60CM CYCLE  
DIGITRONIC  
DISHWASHER**

EDV606SX



**7KG ELECTRIC  
CONDENSER DRYER**

TCD7E



**7.5KG FRONT LOADING  
WASHING MACHINE**

T7E1200FL-2



**7.5KG VENTED DRYER**

TVD7U

**Baumatic®**



**60CM CERAMIC COOKTOP**

BCT4



**60CM GAS COOKTOP**

BG4S



**60CM INDUCTION COOKTOP**

BHI650



**60CM FAN FORCED OVEN**

BO7C



**60CM PYROLYTIC MULTIFUNCTION OVEN**

BMOP12



**90CM FREESTANDING GAS/ELECTRIC OVEN**

BAF90EG



**60CM DISHWASHER 14 PLACE SETTING**

BMD14S



**60CM SLIDEOUT RANGEHOOD**

GEH6017



**52CM UNDERMOUNT RANGEHOOD**

GUH52SD

**VENETO™**



**60CM CERAMIC COOKTOP**

VCER60

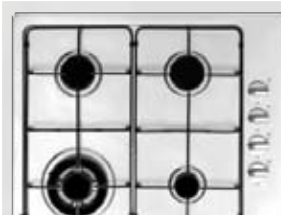

**60CM GAS COOKTOP**

VH64FSS



**60CM 5 FUNCTION OVEN**

VO60SS



**60CM SLIDEOUT RANGEHOOD**

VSL60SS

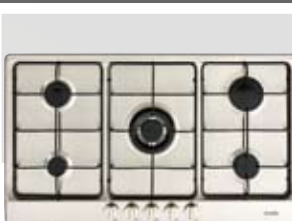

**90CM GAS COOKTOP**

VH90FSS



**90CM 6 FUNCTION OVEN**

VO90SS



**90CM SLIDEOUT RANGEHOOD**

SL10190ISS-4

# Sinks

Oliveri



**APOLLO DOUBLE BOWL SINK**

AP1464



**DIAZ DOUBLE UNDERMOUNT SINK**

DZ10U



**NU-PETITE DOUBLE BOWL TOPMOUNT SINK WITH DOUBLE DRAINER**

NP653



**SPECTRA 1 & 1/2 BOWL GUNMETAL SINK**

SB35GM



**SONETTO 1 & 3/4 BOWL TOPMOUNT SINK WITH DRAINER**

SN1011



**SANTORINI BLACK 1 & 3/4 BOWL TOPMOUNT SINK WITH DRAINER**

ST-BL1510

HÄFELE



**SQUARELINE 1 & 3/4 BOWL SINK & DRAINER**

567.30.776



**SQUARELINE 1 & 3/4 BOWL SINK**

567.33.076



**UNDERMOUNT SINGLE BOWL SINK, STAINLESS STEEL**

567.33.130



**SQUARELINE SINGLE BOWL SINK**

567.30.246



**SQUARELINE LINEN SINGLE UNDERMOUNT SINK GUNMETAL**

567.30.856



**50L LAUNDRY TUB, STAINLESS STEEL**

567.30.120





**LAGO DOUBLE BOWL SINK**

LG200



**DAINTREE DOUBLE BOWL UNDERMOUNT SINK**

Q200U



**EURONOX 1 & 7/8 BOWL SINK & DRAINER**

EUA180L



**SCHOCK TYPOS 1 & 3/4 BOWL SINK WITH DRAINER ONYX**

TD200B



**SCHOCK TYPOS DOUBLE BOWL UNDERMOUNT SINK ONYX**

TN200B



**SINGLE BOWL LAUNDRY SINK 45L**

LT120



**NUGLEAM SINGLE BOWL SINK & DRAINER**

73101



**SQUARELINE SINGLE BOWL SINK & DRAINER**

73141



**SQUARELINE PLUS SINGLE BOWL**

73178



**NUGLEAM 1 & 3/4 BOWL SINK & DRAINER**

73105



**SQUARELINE 1 & 3/4 BOWL SINK & DRAINER**

73145



**SQUARELINE PLUS DOUBLE BOWL**

73179

# Tapware

**ARMANDO VICARIO**  
rubinetterie



**PULL OUT KITCHEN MIXER**  
5 Star WELS rating,  
5 Litres per minute  
Made in Italy SK5-AV



**LUZ PULL OUT KITCHEN MIXER**  
4 Star WELS rating,  
7.5 Litres per minute  
Made in Italy LUZ



**TINK PULL-OUT KITCHEN MIXER**  
4 Star WELS rating,  
7.5 Litres per minute, Black  
Made in Italy TINKD-B

*Oliveri*



**ESSENTIALS PULL-OUT RIGHT ANGLE MIXER**  
4 Star WELS rating,  
7.5 litres per minute ES570-P



**ESSENTE STAINLESS GOOSE NECK PULL-OUT MIXER**  
4 Star WELS rating,  
7.5 litres per minute SS2525



**VILO PULL-OUT SPRAY MIXER**  
4 Star WELS rating,  
6.5 litres per minute VT0426C

**METHVEN**



**CULINARY GOOSENECK PULL-OUT SINK MIXER**  
4 Star WELS rating  
7.5 Litres per minute 01-2329A



**URBAN PULL-OUT SINK MIXER - CHROME/BLACK**  
4 Star WELS rating  
7.5 Litres per minute 01-0325



**GASTON PULL DOWN SINK MIXER - CHROME/BLACK**  
4 Star WELS rating  
7.5 Litres per minute 02-1055

**mixx**  
TAPWARE and ACCESSORIES  
By Brasshards



**KUBOS SINK MIXER MATT BLACK**  
5 Star WELS Rating  
5.5 litres per minute 11SL161ML



**TRINSIK SINK MIXER**  
5 Star WELS Rating  
5.5 litres per minute 11SL771CL



**ALPINE PULLOUT SINK MIXER**  
4 Star WELS Rating  
7.5 litres per minute 7SL306CL

**PHOENIX**  
TAPWARE, SHOWERS & ACCESSORIES



**VIVID SLIMLINE SINK MIXER CHROME**  
4 Star WELS Rating  
7.5 litres per minute VS735CHR



**VIVID SLIMLINE PULL OUT SINK MIXER MATT BLACK**  
5 Star WELS Rating  
5 litres per minute VS7105-10



**BLIX KITCHEN MIXER BRUSHED NICKEL**  
5 Star WELS Rating  
6 litres per minute 10473100BN

## Filtration & Waste Disposal



**ZIP HYDROTAP CLASSIC BC**  
Zip HydroTap Classic offers filtered boiling and chilled water with a single under bench command centre.

HT1784



**Zip HydroTap Arc BCS**  
The Zip HydroTap Arc will complement any kitchen or office space. With filtered boiling, chilled and sparkling water it features a single under bench command centre.

HT2783

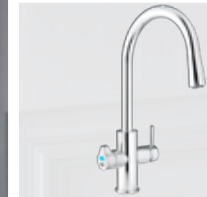

**Zip HydroTap Celsius All-In-One BCSHA**  
Featuring filtered boiling, chilled & sparkling water, plus unfiltered hot and cold, Zip HydroTap All-In-One Celsius Arc offers every kind of water in one stylish tap.

MT2790



**PUREMIX-Z7 Drinking Water Filter System**

The PUREMIX-Z7 high-flow under-sink water filter system, providing pure and healthy drinking water from your very own existing home tap. No extra tap is required, as it fits to the connection of any standard mixer tap.

PUREMIX-Z7



**INSINKERATOR® EVOLUTION 100**

With 2-stage grind and quiet technologies, 0.75 hp, auto-reverse grind system, stainless steel grind chamber, grinding elements and built-in air switch in chrome. Guarantee: 5 Year parts and service.

EVOLUTION 100



**INSINKERATOR® MODEL 66**

With 1-stage grind technology, .75 hp motor, auto-reverse grind system, stainless steel grind elements and built-in air switch in chrome. Guarantee: 4 Year parts and service.

MODEL 66



**INSINKERATOR® MODEL 56**

With 1-stage grind technology, 0.55 hp motor and stainless-steel grind elements. Guarantee: 3 Year parts and service.

MODEL 56



# Pantry Solutions

The Principal Range utilises Kessebohmer by Häfele to add functionality to your kitchen. Manufactured in Germany, Kessebohmer by Häfele accessories are the perfect combination of style and practicality.

**HÄFELE**  
KESSEBÖHMER





**KESSEBÖHMER DISPENSA**  
 Chrome Arena Style 546.51.321  
 Anthracite Arena Style 546.45.411



**KESSEBÖHMER CONVOY CENTRO**  
 Glass Arena Vario 545.81.683



**KESSEBÖHMER TANDEM**  
 Chrome Arena Style 545.94.612  
 Anthracite Arena Style 545.93.431



**KESSEBÖHMER CONVOY LAVIDO**  
 Glass Arena Vario 545.62.516  
 Anthracite Arena Style 549.63.916



**ANTHRACITE ARENA STYLE**



**CHROME ARENA STYLE**

# Base Storage

**HÄFELE**  
 KESSEBÖHMER



**KESSEBÖHMER NO15 ARENA STYLE**  
 2 Tier pullout 549.24.320



**KESSEBÖHMER NO15 ARENA STYLE**  
 Towel rail pullout 549.24.333



**KESSEBÖHMER NO15 ARENA STYLE**  
 Baking tray pullout 549.24.343



**KESSEBÖHMER COMFORT II PULLOUT R/H, LEFT MOUNT**  
 Chrome Arena Style 545.53.674  
 Anthracite Style 545.53.477



**KESSEBÖHMER DISPENSA JUNIOR III**  
 Arena Style 545.11.614



**HÄFELE 150MM SMALL & LARGE WIRE PULLOUT**  
 Wire baskets 495.35.000



**HAFELE PULLOUT STORAGE UNIT**  
 Wire baskets 545.26.293



**HAFELE DOUBLE SOFT CLOSE PULL OUT STORAGE BASKETS, SMALL & LARGE**  
 450mm 495.34.010  
 600mm 495.34.011

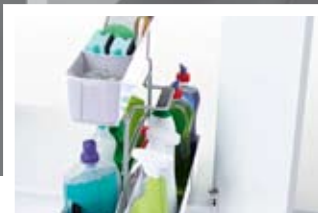

**KESSEBÖHMER CLEANING AGENT PULLOUT**  
 White Plastic 549.24.912



**KESSEBÖHMER COOKING AGENT PULLOUT**  
 Silver plastic 549.24.972



**KESSEBÖHMER POTERO I**  
 White /Chrome 545.48.760



**KESSEBÖHMER POTERO II**  
 White /Chrome 545.48.761



# Corner Solutions

**HÄFELE**  
**KESSEBÖHMER** *ninka*



**KESSEBOHMER  
LE MANS II CORNER  
UNIT, (Right Hand)**

Arena Style RH 541.32.620  
 Arena Style LH 541.32.621



**KESSEBOHMER  
LE MANS II CORNER  
UNIT, (Right Hand)**

Anthracite Arena RH 541.31.870  
 Anthracite Arena LH 541.31.871



**HÄFELE SOFT CLOSE  
MAGIC CORNER UNIT**

Wire basket LH & RH 548.16.202



**KESSEBOHMER  
MAGIC CORNER**

Arena Classic RH 546.17.602  
 Arena Classic LH 546.17.603



**NINKA MONDO CORNER  
REVOLVING UNIT**

542.24.813



**KESSEBOHMER  
270 CAROUSEL UNIT**

Arena Classic 542.31.250



**NINKA CORNER  
CAROUSEL UNIT**

White plastic 541.45.837



**ANTHRACITE  
ARENA STYLE**



**CHROME  
ARENA STYLE**



**CHROME  
ARENA CLASSIC**

# Overhead Storage

**HÄFELE**  
 KESSEBÖHMER



**KESSEBÖHMER iMOVE  
 SINGLE SHELF**

White 504.68.617  
 Anthracite 504.68.313



**KESSEBÖHMER iMOVE  
 DOUBLE SHELF**

White 504.68.623  
 Anthracite 504.68.323

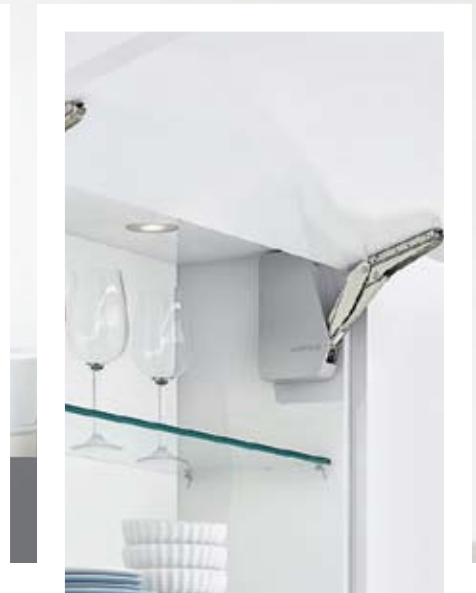

**FREE FLAP CABINET**

800mm 561.02.164  
 900mm 561.02.163

# Drawer Organisation

**HÄFELE**  
KESSEBÖHMER *ninka*

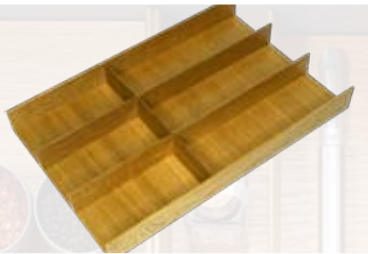

### FINELINE CUTLERY INSERT

To suit 450mm drawer  
Natural Oak

556.03.400

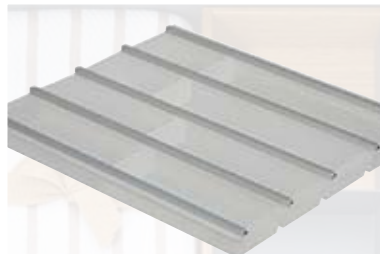

### NINKA CUSIO CUTLEY INSERT

To suit 450mm drawer  
Translucent white

556.24.842

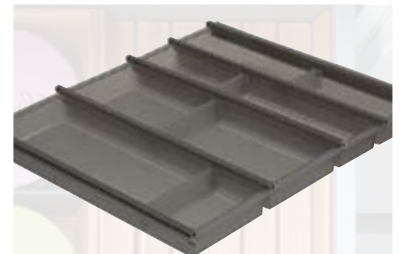

### NINKA CUSIO CUTLEY INSERT

To suit 900mm drawer  
Translucent graphite

556.24.962



### HÄFELE CLASSIC CUTLERY TRAY

To suit 600mm drawer  
Silver

495.42.004



### HAFELE SMART CUTLERY TRAY - ALTO

To suit 450mm drawer

495.42.001



### HAFELE CLASSICO CUTLERY TRAY

To suit 900mm drawer  
White

495.42.007

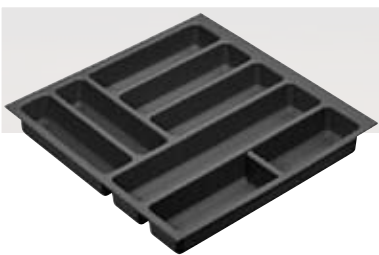

### HAFELE GRIP CUTLERY TRAY

To suit 600mm drawer  
Anthracite Pearl

495.42.008



### HAFELE SMART CUTLERY TRAY

To Suit 600mm drawer  
White

556.60.789



### HAFELE SPICE RACK INSERT

To suit 450mm drawer  
White

495.42.009



# Waste & Laundry Management

**HÄFELE**

**ninka** **Hailo**



**HÄFELE 10L DOOR MOUNTED WASTE BIN**

White, suits 400mm cabinet  
495.43.000



**HÄFELE 10L DOOR MOUNTED WASTE BIN**

Chrome, suits 400mm cabinet  
495.43.001



**HAILO 5L DOOR MOUNTED BIN**

Suits 300mm cabinet  
495.43.003



**HAILO 18L DOOR MOUNTED BIN**

Suits 450mm cabinet  
502.62.710



**HÄFELE 1 X 40L SINGLE PULL OUT WASTE BIN**

Suits 400mm cabinet  
502.70.520



**HÄFELE 2 X 15L SOFT CLOSE, DOUBLE PULL OUT BIN**

Suits 400mm cabinet  
495.43.031



**HÄFELE 2 X 20L SOFT CLOSE, DOUBLE PULL OUT BIN**

Suits 400mm cabinet  
495.43.030



**NINKA 4.2L BIO BIN**

Suits 400mm cabinet  
495.43.002





**HAILO 2 X 38L DOUBLE PULL OUT WASTE BIN**

Suits 450mm cabinet  
503.70.322



**HAILO 2 X 15L DOUBLE PULL OUT BIN**

Suits 300mm cabinet  
495.43.004



**HAILO 2 X 18L DOUBLE PULL OUT BIN**

Suits 400mm cabinet  
495.43.005



**HÄFELE WORKTOP WASTE BIN**

5L, 237 W x 205 D x 230 H  
502.94.002  
11L, 310 W x 280 D x 300 H  
502.94.000



**HAILO 2 X 33L LAUNDRY PULL OUT HAMPER**

Suits 450mm cabinet  
502.72.702

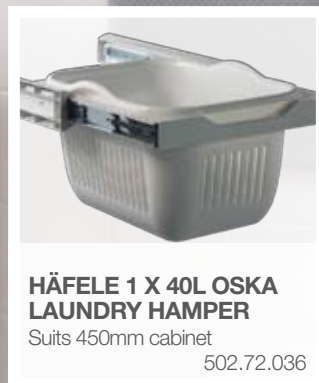

**HÄFELE 1 X 40L OSKA LAUNDRY HAMPER**

Suits 450mm cabinet  
502.72.036

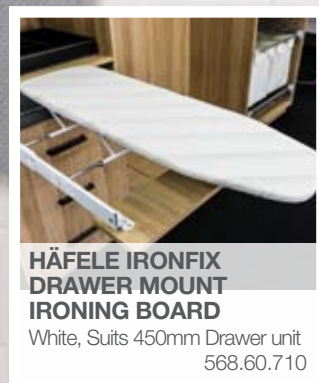

**HÄFELE IRONFIX DRAWER MOUNT IRONING BOARD**

White, Suits 450mm Drawer unit  
568.60.710



**HAILO 8L DOOR MOUNTED BATHROOM BIN**

Suits 400mm cabinet  
502.63.759

# Accessories

HÄFELE 

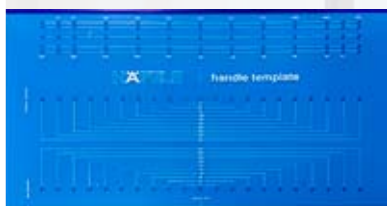

**HANDLE JIG TEMPLATE**

001.35.090



**HÄFELE WINE GLASS RACK**

Chrome

495.01.301



**HÄFELE TOWEL RAIL  
EXTENDABLE 2 ARM**

Silver

495.05.001



**HÄFELE K PUSH  
PUSH TO OPEN, FOR DOORS**

White

356.12.013

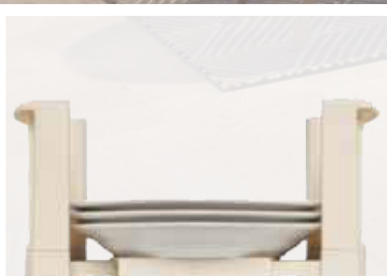

**HÄFELE MOBILE PLATE  
CARRIER**

Small

495.42.105



**HAILO STEP STOOL**

White Grey

505.07.702



**HÄFELE PROTECTION RAILS  
300MM LONG**

Stainless Steel

808.90.090

# Lighting

## HÄFELE



**HÄFELE DOWNLIGHT 12V  
2 PIECE KIT**

Warm White 450.72.410  
Cool White 450.72.412



**HÄFELE DOWNLIGHT 12V  
3 PIECE KIT**

Warm White 450.72.414  
Cool White 450.72.416



**HÄFELE 5M STRIP LIGHTING  
12V LIGHT KIT**

Warm White 450.72.404  
Cool White 450.72.408



**DRAWER SENSOR LIGHT**

Daylight White 833.87.020



**HÄFELE BLUETOOTH  
SOUND SYSTEM**

12V 450.72.418



**HÄFELE CONNECT BLE BOX**

For controlling lighting through Häfele  
lighting app wirelessly

850.00.005

# Planning tips

## WHAT TO DO

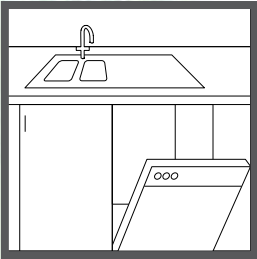

For ease of plumbing, place a dishwasher near the sink and allow a minimum 600mm space to 'house' it.

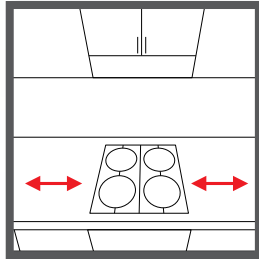

Allow a minimum 450mm either side of the cooktop for safety and extra working space.

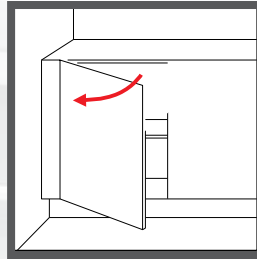

Leave space between a cabinet and your wall so doors can be fully opened and the cabinet easily accessed.

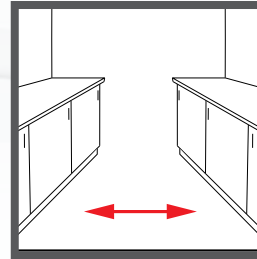

Allow a minimum 1.2m between opposite cabinets for maneuverability.

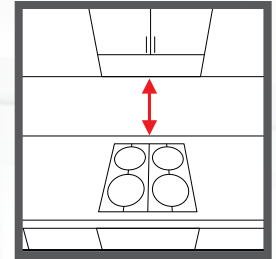

Allow a minimum 650mm between your cooktop and rangehood.

## WHAT NOT TO DO

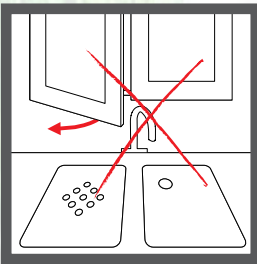

Don't place tall tapware in front of an opening window.

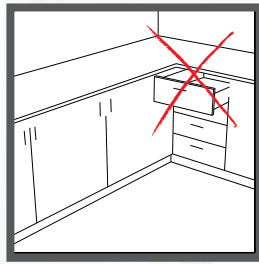

Don't place drawers in a corner where they can block other cabinets.

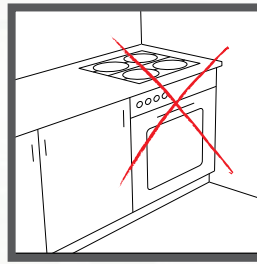

Don't place a cooktop next to a wall where it can cause overheating. Allow a minimum 450mm on either side.

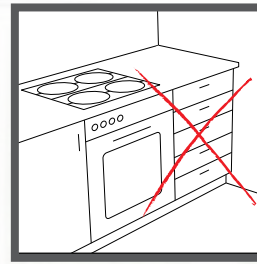

Don't install a full set of drawers next to a cooktop. This can provide easy access to a hot cooking area for young children.

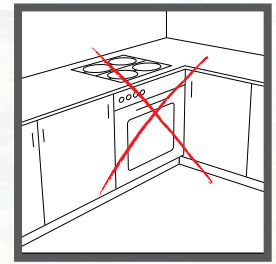

Don't place your dishwasher or stove in a corner where it can block other cabinets.

# Design hints & tips

## Kitchen design example

Shown here is a sample of a kitchen design. This design highlights the cupboards used, and indicates where panels should be used. You'll notice that we have marked in a solid line, indicating the wall perimeter of the kitchen.

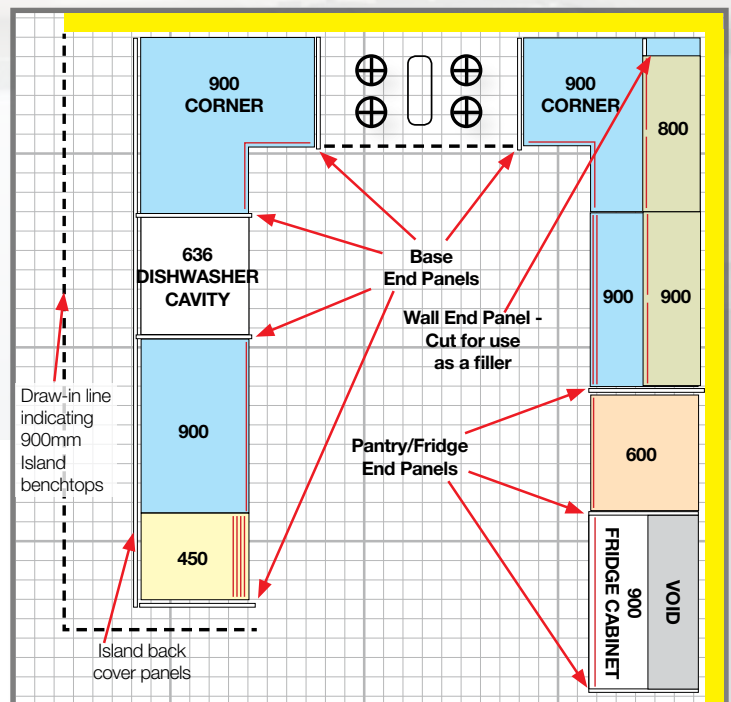



# End Panels & Cavities

## TYPES OF PANELS AND THEIR PURPOSES

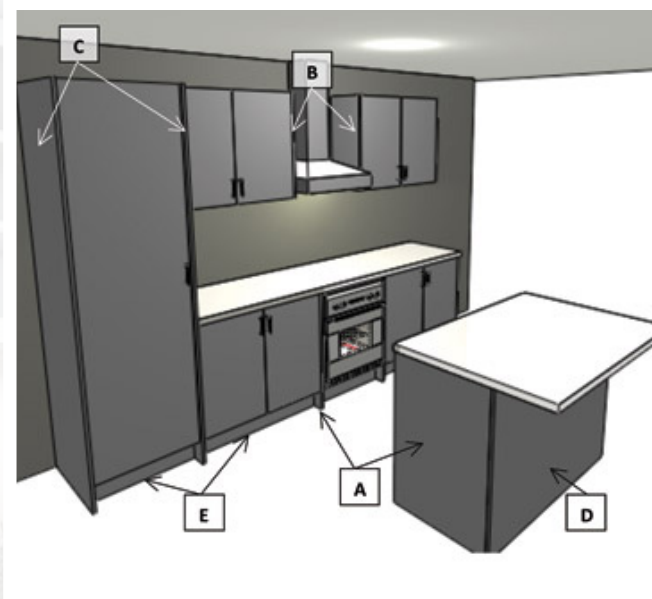

There are five types of panel you can install to give your new kitchen a clean finish. Each panel has a different purpose, explained below.

### **A. Base End Panel**

Finishing exposed sides of base cabinets; placed either side of dishwasher cavity.

### **B. Wall End Panel**

Finishing exposed sides of wall cabinets; used as filler panels (after cutting).

### **C. Pantry End Panel**

Finishing exposed sides of pantry cabinets; to create a fridge box (the sides of the fridge wall cabinet); used as filler panels.

### **D. Island Back Panel**

Finishing the cabinet backs of an island bench.

### **E. Kickboard**

Hides adjustable feet of the base and pantry cabinets.

## KITCHEN CAVITIES

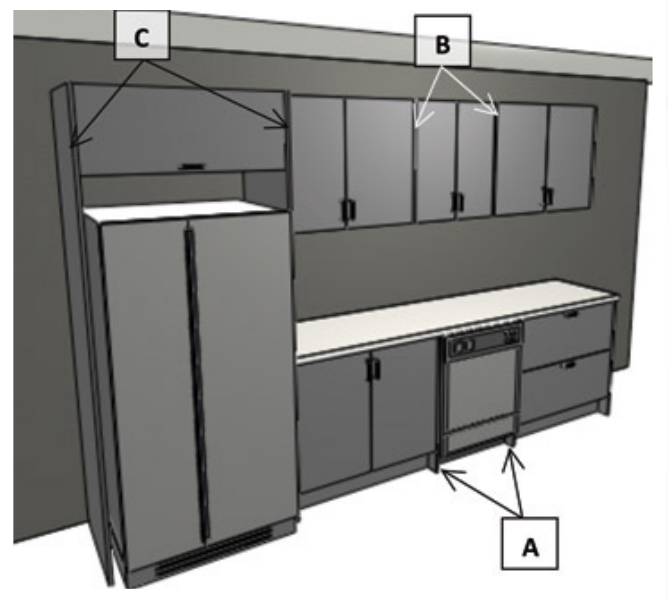

Here are some useful measurements when planning out your kitchen cavities, commonly spaces for dishwasher and fridge.

**Dishwasher cavity:** Leave a space of 636mm or more between two base cabinets. Base end panels are 18mm thick, so when you fix a panel to each exposed cabinet side there'll be at least 600mm of space for your dishwasher.

When using end panels for a dishwasher cavity, use wall end panels either side of a 600mm wall cabinet to keep alignment of your base and wall cabinets.

**Fridge cavity:** A space of 900mm in width should be sufficient, but check before you go ahead. You can also choose to mount an overhead fridge cabinet, between two pantry end panels. As the image shows, the fridge wall cabinet will mount to the front of the pantry end panels.

# Measuring tips

The first thing you need when you're thinking about a new kitchen is a working plan of your space. It's your starting point for designing, costing and building your perfect kitchen. We'll show you how to measure your kitchen space, locate your various services and fixtures, and then sketch your space on the grid provided. With this sketch, you'll be able to plot a kitchen that suits your space and your needs. It is well worth taking the time to do this step correctly. It doesn't have to be a work of art, but it does need to be accurate.

## 1. Begin by measuring your walls

When measuring the widths of your walls, ideally measure at approximately 1m from the floor, keeping the measuring tape taut at all times (grab a friend to help with this step!). Starting in one corner of the room, measure to the adjacent wall and write down the measurement in millimetres. Go all around the room until all walls are measured. On a spare piece of paper, create a quick, rough sketch of your room shape and note your measurements against it as you move around the room. This will help to ensure you don't accidentally muddle up your measurements later on!

## 2. Measure your ceiling height

You'll need to know where to position the cabinetry on your wall, and that you have enough room for them. It's best to measure your ceiling height in several places, as floors can be uneven. Write down your measurements.

## 3. Create a sketch

Use the grid on the next page to create a sketch of your kitchen floor plan, and then transfer your measurements. See above for example.

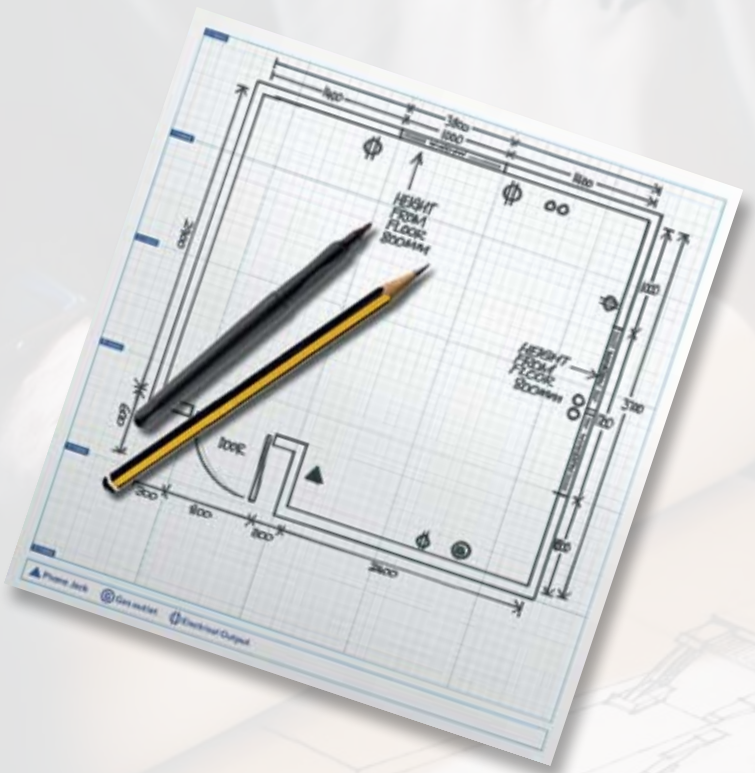

## 4. Measure your fixtures

Measure any windows and doors, remembering to always measure from the outside edge of the architrave. Also take measurements of their location on the wall, i.e. how far is the window located from the corner of the wall and how high is it from the floor.

## 5. Locate your services

Find all your utility and services like electrical points, gas and plumbing and mark the relevant symbols onto your plan. Again, remember to note their height and position on the wall.

*Symbols for the different utilities are shown below.*

### UTILITIES SYMBOLS



PHONE JACK



GAS OUTLET



ELECTRICAL OUTPUT



WATER OUTPUT

If you're still a bit uncertain about measuring up your kitchen properly, ask one of our kitchen expert's in-store for more information.

# Design Space

Measure and map out doors and windows.  
Make a note of which way they open.  
Locate and mark your plumbing and electrical outlets.  
Transfer all your measurements to the grid, and start designing!

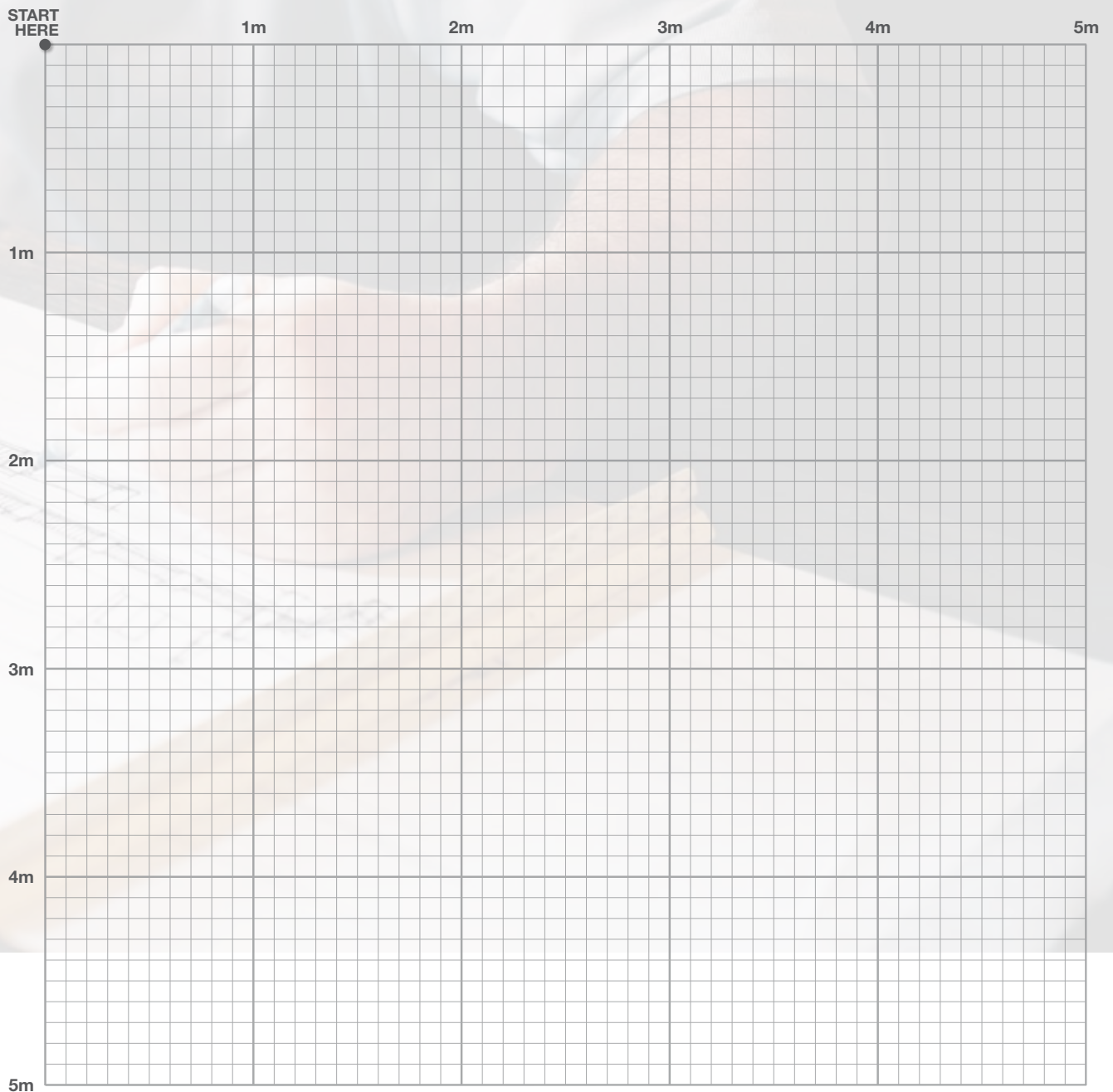



# Delivery & Install

## HOME DELIVERY

Your Principal kitchen is available for you to take home from your local store, flat-packed for transportation. Or we can arrange delivery to your home if you'd prefer, for an additional fee. Just ask one of our staff for more information (NB: 14 working days should be allowed for any items that need to be ordered in to complete your kitchen).



## INSTALL IT YOURSELF

The Principal kitchen range is conveniently packed, making it simple for you to assemble and install. All cabinets are pre-drilled with all assembly hardware included. Alternatively, speak to our staff who will be able to refer you to a suitable local trade professional to quote for the installation of your kitchen.



Speak to one of our friendly kitchen consultants to get a copy of the Installation Guide

# Essentials Checklist

Every great Kitchen project needs to have all the essential components. Use this checklist to make sure you have all your bases covered before you build.

## Have you marked on your plan before designing:

- Water and waste
- Doorways and windows
- Electrical outlets and existing lighting

## Have you selected your finishes:

- Doors and drawer fronts p.6
- Benchtop p.46
- Splashback p.50
- Wall paint
- Flooring

## Have you included these essentials in your design:

- Drawers for cutlery
- Fridge
- Pantry p.44
- Handles for your cupboards p.52
- Oven p.54
- Cooktop p.54
- Rangehood p.54
- Sink p.56
- Bin p.66

## Have you selected your functional storage?:

- Pantry solutions p.60
- Overhead storage p.64
- Base storage p.62
- Drawer organisation p.65
- Corner solution p.63
- Waste & Laundry management p.66

# 6 Cabinet Design

To help determine which kitchen is the right match, we have developed a pricing comparison guide for you. Please see in-store for Principal kitchens pricing.

Based on a typical six cabinet straight line kitchen, the comparison guide makes it easy to compare the pricing for each of the styles.

Cabinets	Doors & Drawer Fronts	Panels	Benchtop
1 x 450mm Pantry	1 x 450mm Pantry Door	2 x Pantry End	1 x 600mm (deep) Laminate
1 x 900mm 2-Drawer	1 x 900mm 2-Drawer Pack	1 x Base End	
1 x 600mm Oven Base	1 x 450mm Door	1 x 600mm Oven Panel Pack	
1 x 450mm Base	1 x 450mm 4-Drawer Pack	2 x 2400mm Kickboard	
1 x 450mm 4-Drawer	2 x 300mm Door		
1 x 600mm 2-Door Base			

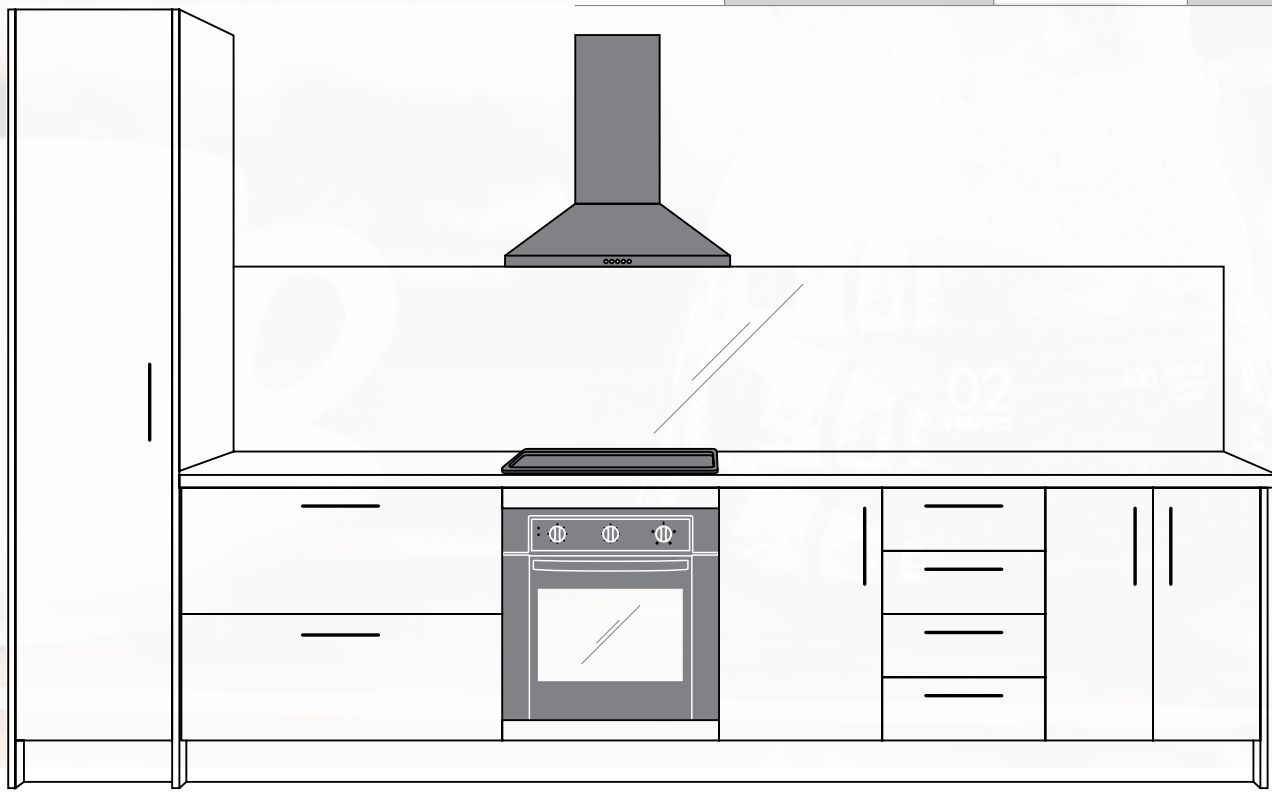

## Design Plan

PANTRY 450	DRAWER 900	OVEN 600	BASE 450	DRAWER 450	BASE 600
TEP	TEP				BEP





## Own your new kitchen sooner.

Zip is a simple, flexible way to get the things you need now and pay for them later, interest free.



Great for bits and bobs

**Up to \$1000\***



Ideal for the bigger jobs

**Over \$1000\*\***



### Reusable account

Apply for a reusable account with a limit to suit you.



### No upfront payments

We pay the store for you, and you take the goods the same day.



### Interest free

Easy interest free payments.  
No hidden fees.



### Flexible repayments

Choose a repayment amount and schedule to suit you.

[zip.co /apply](https://zip.co/apply)

\*Minimum monthly repayments are required. A monthly account fee of \$6.00 applies. Pay your closing balance in full each month and we'll waive the fee.

\*\*Minimum monthly repayments are required. Paying only the minimum monthly repayment amount will not pay out the purchase within the interest free period. Any balance outstanding at the expiry of the interest free period for the purchase will be charged interest at the contractual rate, currently 19.9%. A \$6 monthly account fee applies. A one-off establishment fee may apply.

Available to approved applicants only. Terms & Conditions apply and are available on application. See your contract for further details. Credit provided by zipMoney Payments Pty Limited (ABN 58 164 440 993, Australian Credit Licence Number 441878).

# Warranty Information

## Warranty Against Defects

1. Our goods come with guarantees that cannot be excluded under the Australian Consumer Law. You are entitled to a replacement or refund for a major failure and for compensation for any other reasonably foreseeable loss or damage. You are also entitled to have the goods repaired or replaced if the goods fail to be of acceptable quality and the failure does not amount to a major failure. Where a failure does not amount to a major failure, the Independent Hardware Group is entitled to choose between providing you with a repair, replacement or refund. To obtain compensation, you would need to provide documentary evidence of the loss or damage suffered, and documentary evidence that such loss or damage was a reasonably foreseeable consequence of a failure by the Independent Hardware Group to comply with a consumer guarantee under the Australian Consumer Law. Such evidence may include photographs, statutory declarations, receipts or reports (eg from your doctor), depending on the loss or damage.
2. In addition to all rights and remedies to which you may be entitled under the Competition and Consumer Act 2010 and any other relevant legislation, the manufacturer warrants Principal kitchens to be free from defects in workmanship for a period of 10 years from the date of purchase.
3. In order to claim under this warranty simply visit the Independent Hardware Group store (Mitre 10, Home Timber & Hardware, Thrifty-Link or True Value Hardware), along with proof of purchase (typically this will be a receipt) and evidence of the fault (for example, a photo of the fault in the relevant product). Any cost incurred by you in bringing the product or evidence of the fault to the service desk will be borne by you. An inspection may be required. We will then arrange, at our option or at the option of the manufacturer, to either repair or replace the product, or refund your money and take back the product — in accordance with our Returns Policy, a copy of which is available in store.
4. Our liability under this manufacturer's warranty is subject to us being satisfied that a defect was caused by defective workmanship, and was not caused by or substantially contributed to by other factors or circumstances beyond our control, including (but not limited to) defective installation, maintenance or repair, alteration or modification of the product in a manner not recommended by the manufacturers or any neglect, misuse or excessive use.
5. The benefits conferred by this manufacturer's warranty are in addition to all rights and remedies conveyed by the Competition and Consumer Act 2010, and any other statutory rights to which you may already be entitled, and this warranty does not exclude, restrict or modify any such rights or remedies that are implied by law.
6. This warranty is provided by the Independent Hardware Group - Mitre 10 Australia Pty Ltd ABN 98 009 713 704. Home Timber & Hardware Group Pty Ltd ABN 64 004 037 049. 1/19 Corporate Drive, Heatherton, VIC 3202. Phone: 1300 880 440.

## IMPORTANT - PLEASE READ:

All information and tips in this publication are of a general nature only and The Independent Hardware Group does not warrant the accuracy or completeness of the information and tips in this publication. This publication is not intended to be a substitute for expert advice. The Independent Hardware Group advises you to always consult an experienced and qualified person when undertaking jobs of this kind (including consulting a qualified trades person such as an electrician or plumber where relevant expert services are required). You should also consider any safety precautions that may be necessary when undertaking the work described in this publication (including wearing any necessary safety equipment such as safety glasses, goggles or ear protectors or hard hats). The information and tips in this publication are provided on the basis that The Independent Hardware Group excludes all liability for any loss or damage which is suffered or incurred (including, but not limited to, indirect and consequential loss or damage and whether or not such loss or damage could have been foreseen) for any personal injury or damage to property whatsoever resulting from the use of the information and tips in this publication. The Independent Hardware Group also notes that there may be laws, regulations or by-laws with which you must comply when undertaking the work described in this publication. You should obtain all necessary permissions and permits from council and/or any other relevant statutory body or authority before carrying out any work. Colours shown are as close as possible to actual product colours. Always confirm your choice with the sample products shown on the in-store displays. Independent Hardware Group reserves the right to correct any printing errors.

Mitre 10 Australia Pty Ltd ABN 98 009 713 704. Home Timber & Hardware Group Pty Ltd ABN 64 004 037 049



# Principal.







Available from your leading independent hardware store: